

# GO.



 Agilent Technologies



## Expanding Lab Capability using Agilent's GC/MS Analyzer with a New Versatile 1000-compound Pesticide MRM Database

-- **“Ready to Go” Analyzer based  
on the most comprehensive  
MRM database**

Kai Meng  
Wilmington, Delaware

# What is a Pesticide GC/MS/MS Analyzer?

A pre-configured and chemically tested GC/TQ system loaded with methods and a 1000-compound Pesticide MRM database for quick installation and start-up.

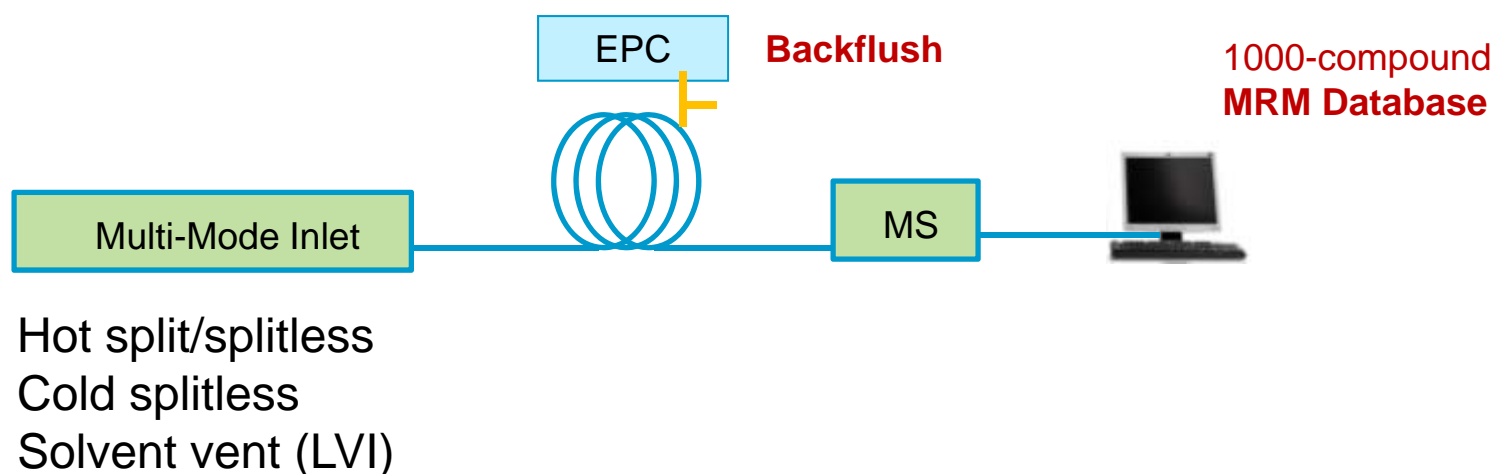

**Backflush: reversing the column flow**

# Pesticide Analyzer System Configuration

## SP1 7890-0501 Setup

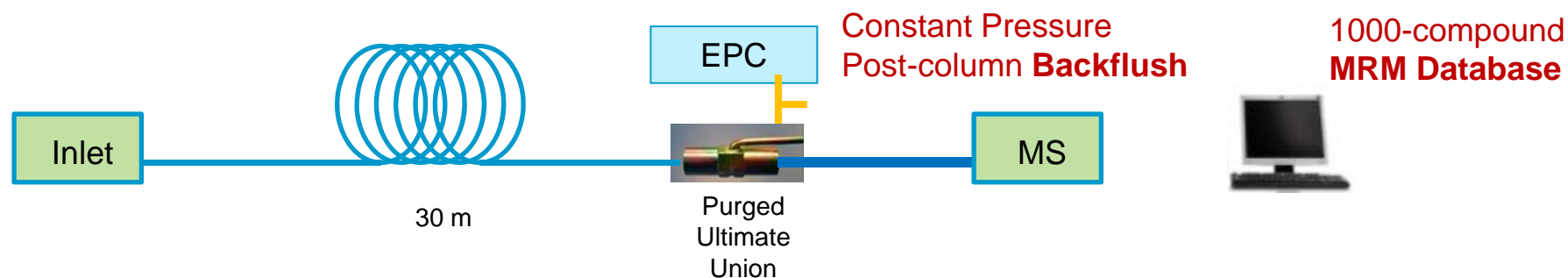

**Flexible to add GC detectors and easily scaled for shorter runtime**

## SP1 7890-0502 Setup

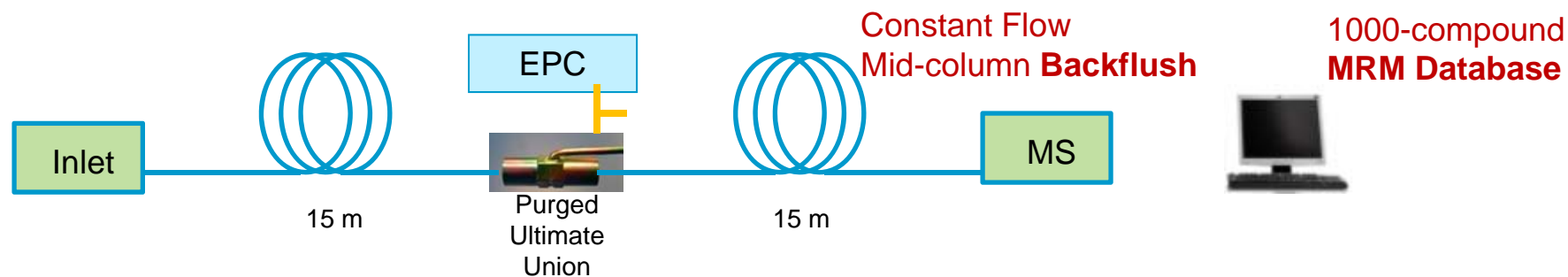

**Provides ultimate performance and shortest cycle time**

# Why Do We Need Backflush?

- With the selectivity of MS/MS, **users cannot see “dirty matrix”**
- MS/MS users want the LOWEST detection limits – **inject more** with large volume injection
- Many late eluting peaks are not “chromatographically ideal” and **leave a residue** throughout the column
- Heavy matrix contaminates the source faster --- **performance is LOST!**

**Backflush ensures the highest data quality with GC/MS/MS!**

**The trade-off is 10-20% decrease in sensitivity.**

# 10% Fish Oil In Acetone: Retention Time Shifts Eliminated With Backflushing

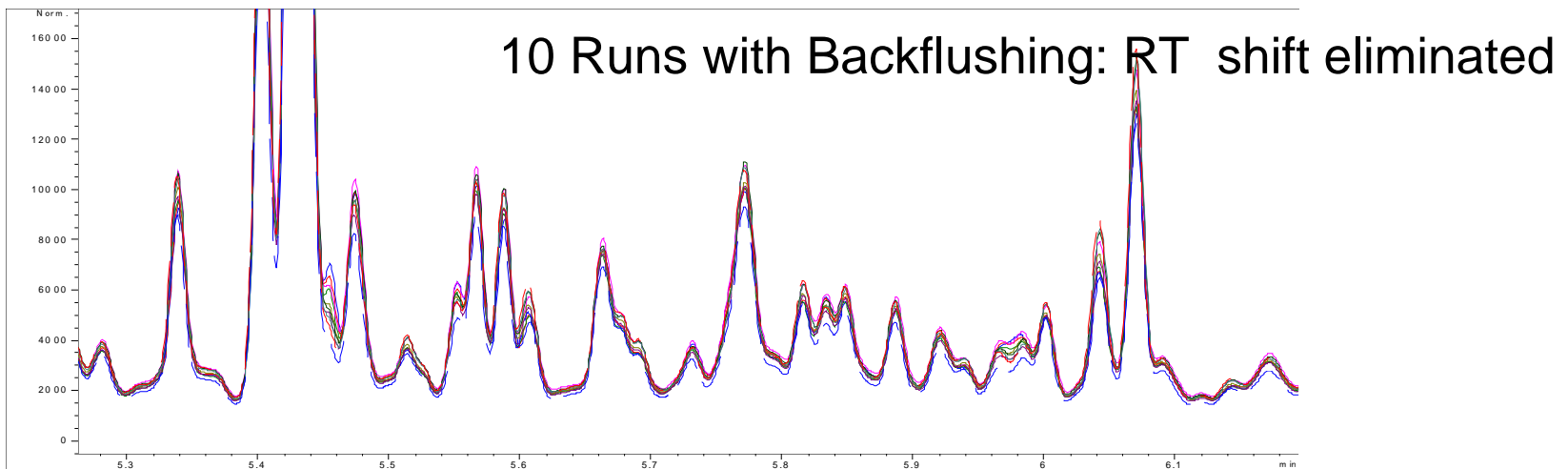
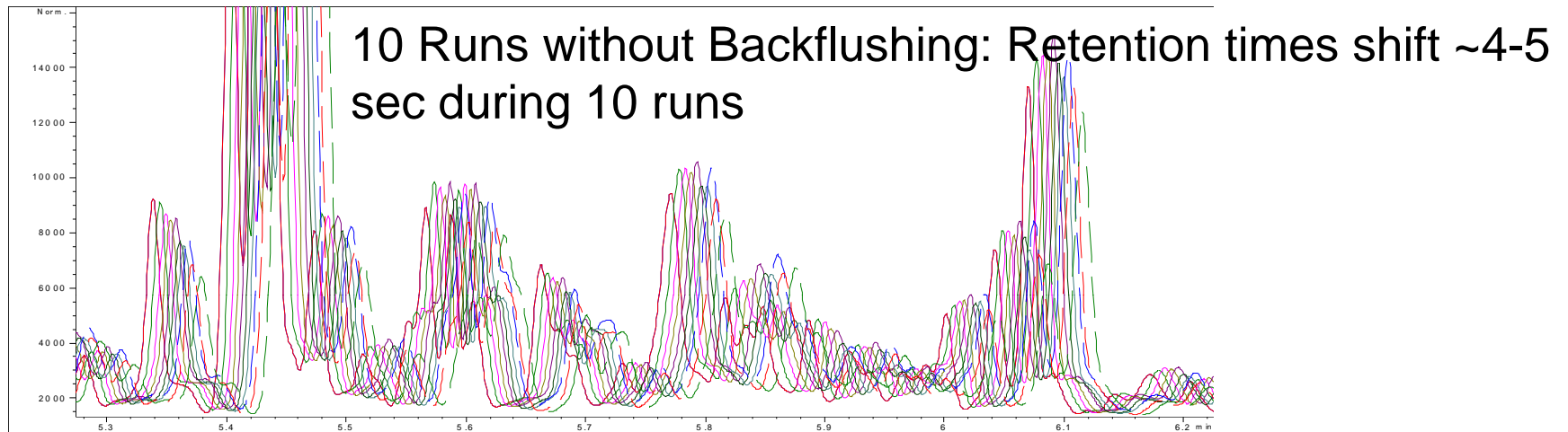

# Milk Extract - Using Bakeout To Remove High Boilers

Cleaning out high boilers is a real problem

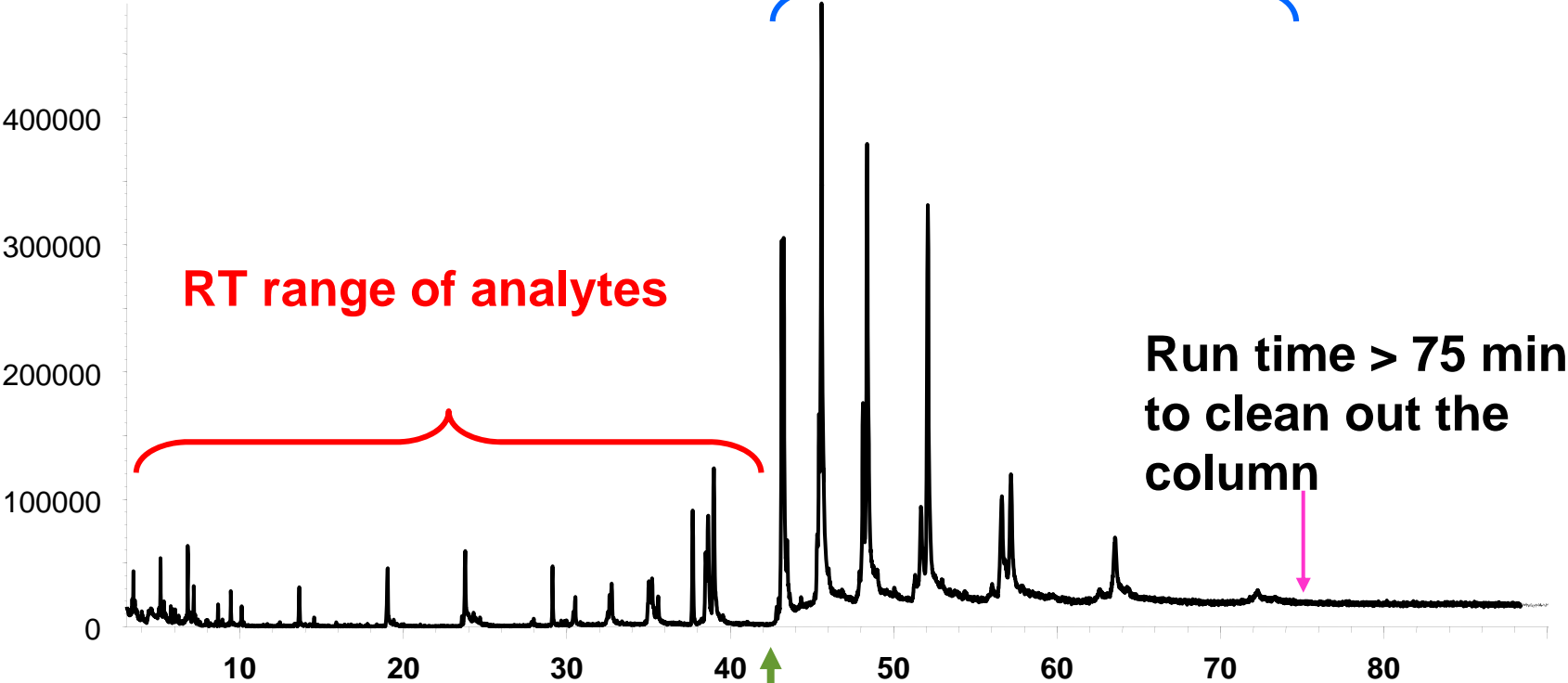

Oven ramps to 320°C to bake off late eluters

# Backflush

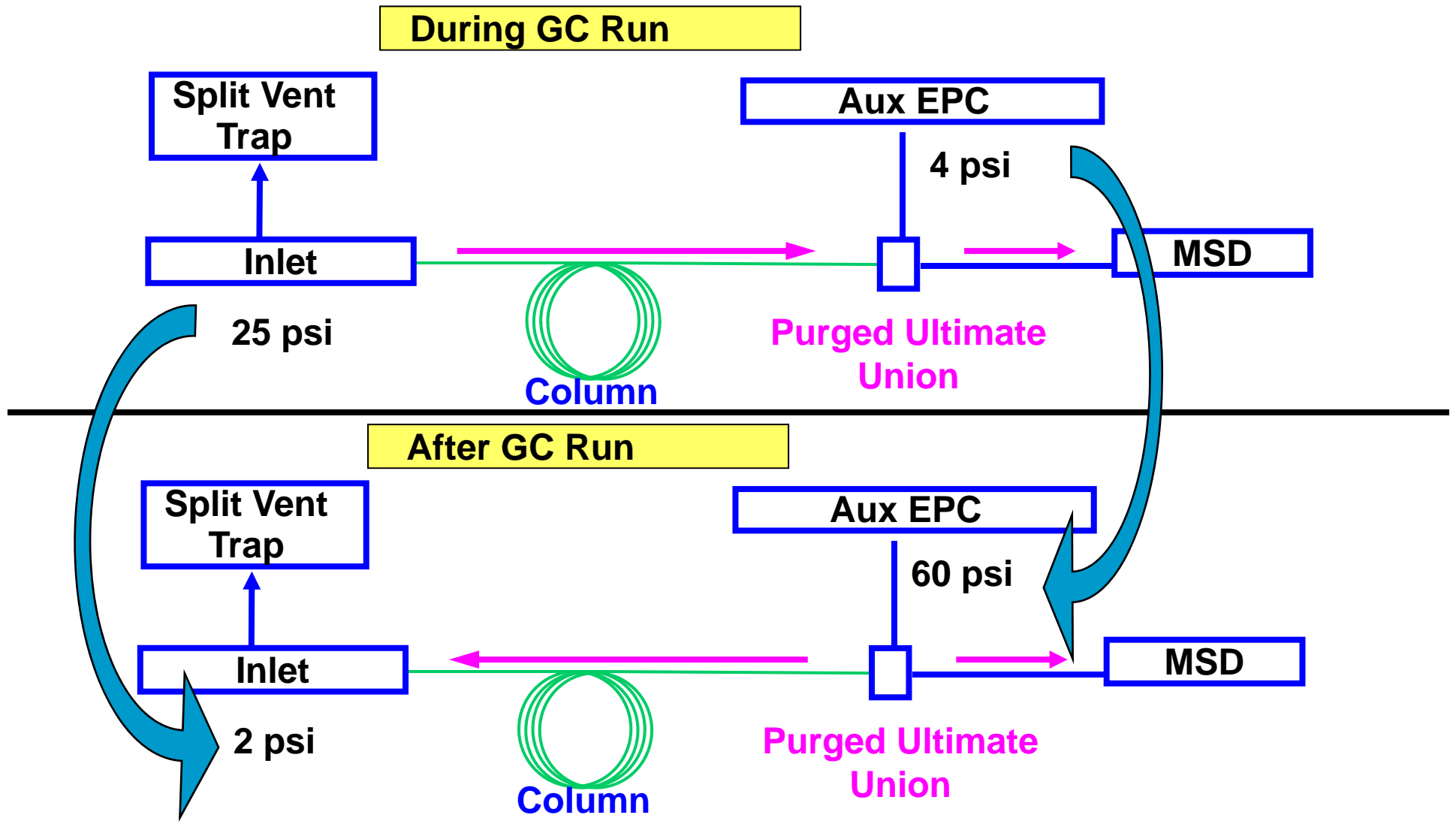

# Heavy Compounds May Be Left in Head of Column After Each Injection

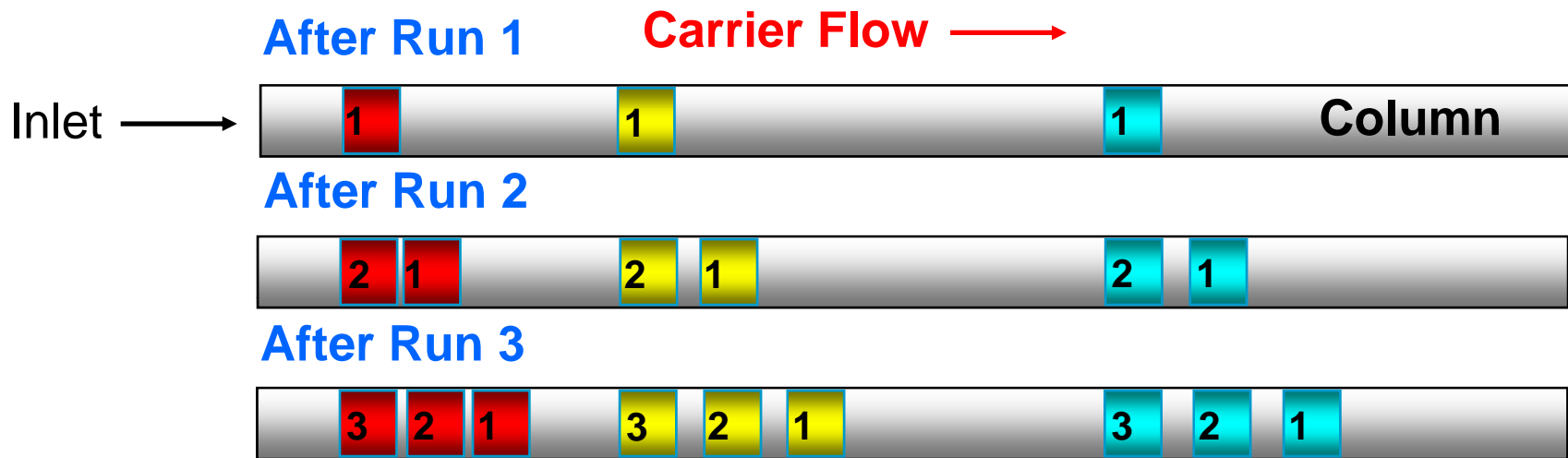

These heavy materials build up and travel further into the column with each injection.

This buildup of heavy materials causes retention time shifts, peak distortion, higher bleed, and loss of sensitivity



# Backflushing After Each Injection

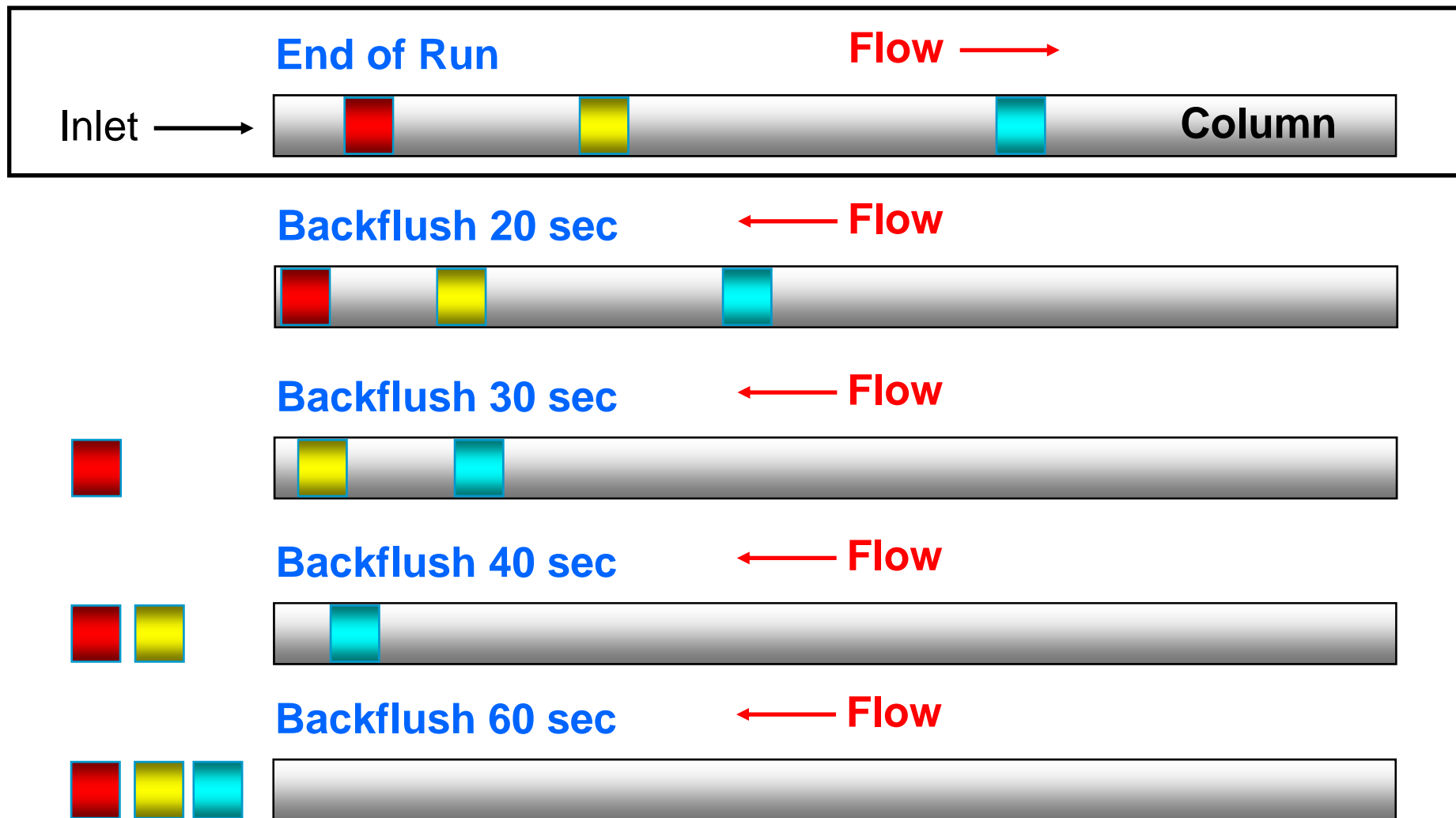

Backflushing removes heavy materials after each injection.

# Milk Extract

Once correct backflushing time is chosen, it will work for ALL high boilers thereafter, because heaviest elute first

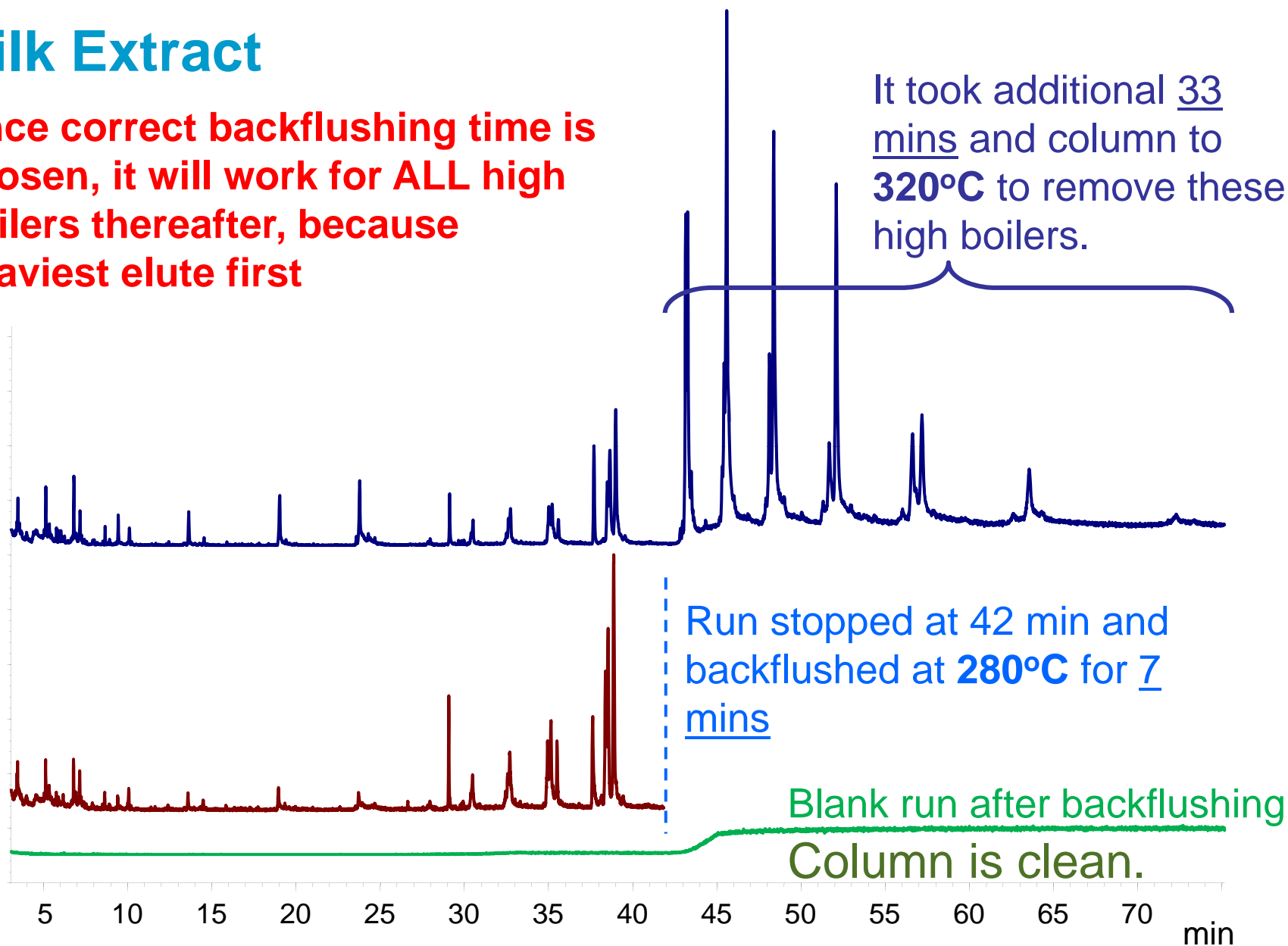

# Backflush: Many Advantages for GC/MS(/MS) Analysis of Complex Samples ('Dirty Matrices')

- Provides more consistent GC retention times
- Provides better, more consistent MS spectra through sequence
  - Reduces chemical noise that due to small carryover of matrix
  - Higher quality quantitation without increase in interfering ions
- Reduces contamination for the source
- Reduces analysis time
- Increases lifetime of analytical column

# Benefits of Agilent GC/MS/MS Pesticide Analyzer

## Retention Time Locking

- **No need to update the time segment RTs** after a column maintenance

## Multimode inlet (MMI)

- injector adds flexibility by including standard, cold split/splitless, solvent vent (**LVI**) capabilities.

## Capillary Flow Technology (CFT) and backflush

- Shorter analysis time, more consistent retention times and spectra, longer column life, and less frequent source cleaning -- **improve uptime.**

## MS/MS MRM Database

- **Optimized and flexible MRM database** of hundreds of compounds

## Pre-config. and factory setup analyzer

- **Factory setup and checked out on pesticide mixture** - ready to generate results on Day One



**But...**

How does the Analyzer work with the list of target pesticides in my lab?

# Agilent's New Comprehensive MRM database with Extensive Flexibility

## ❖ Contains 7000 optimized MRMs for 1000 pesticides

-- over 3000 injections on \$70,000 worth of **chemical standards**

## ❖ Extensive flexibility allows method optimization

- average of 7 MRM transitions with relative intensity for each compound
  - provides alternatives to **avoid matrix interference**
- compound classification, CAS number etc. in excel format
  - allows **easy searching and sorting** for method customization
- three chromatographic methods (constant flow or pressure) with Retention Time and Retention Index
  - allows maximum freedom to follow **customer's workflow**
- absolute intensity for each MRM transition
  - allows **semi-quantitation** without standards

# The Flexibility: 7 transitions; classifications; 3 RTs and RIs

MRM Database.xlsx - Microsoft Excel

Database has RTs (and RIs) to be used with three GC methods (CP, CF, and CF-screening).

1	Common Name	CAS # (format	Molecular Formula	Molecular Weight (average)	Molecular Weight (mono-isotopic)	CAS # (format 2	Classification	Classification	RT - 0502 screening (40.5 min), RTL = 18.111 min	RI - 0502 screenin	RT - 0501 (41.67 min), RTL = 16.593 min	RI - 0501	RT - 0502 (19.75 min), RTL = 9.143 min	RI - 0502
2	1 Acephate	30560-19-1	C4H10NO3PS	183.2	183.0119004	30560191	insecticide	Organophosphorus	6.234		7.610		5.651	
3	1 Acephate	30560-19-1	C4H10NO3PS	183.2	183.0119004	30560191	insecticide	Organophosphorus	6.234		7.610		5.651	
4	1 Acephate	30560-19-1	C4H10NO3PS	183.2	183.0119004	30560191	insecticide	Organophosphorus	6.234		7.610		5.651	
5	1 Acephate	30560-19-1	C4H10NO3PS	183.2	183.0119004	30560191	insecticide	Organophosphorus	6.234		7.610		5.651	
6	1 Acephate	30560-19-1	C4H10NO3PS	183.2	183.0119004	30560191	insecticide	Organophosphorus	6.234		7.610		5.651	
7	2 Etridiazole (Terrazole	2593-15-9	C5H5Cl3N2OS	259.2	259.0119004	2593159	fungicide	Thiadiazole	9.265		7.928		5.843	
8	2 Etridiazole (Terrazole	2593-15-9	C5H5Cl3N2OS	259.2	259.0119004	2593159	fungicide	Thiadiazole	9.265		7.928		5.843	
9	2 Etridiazole (Terrazole	2593-15-9	C5H5Cl3N2OS	259.2	259.0119004	2593159	fungicide	Thiadiazole	9.265		7.928		5.843	
10	2 Etridiazole (Terrazole	2593-15-9	C5H5Cl3N2OS	259.2	259.0119004	2593159	fungicide	Thiadiazole	9.265		7.928		5.843	
11	2 Etridiazole (Terrazole	2593-15-9	C5H5Cl3N2OS	259.2	259.0119004	2593159	fungicide	Thiadiazole	9.265		7.928		5.843	
12	2 Etridiazole (Terrazole	2593-15-9	C5H5Cl3N2OS	259.2	259.0119004	2593159	fungicide	Thiadiazole	9.265		7.928		5.843	
13	2 Etridiazole (Terrazole	2593-15-9	C5H5Cl3N2OS	259.2	259.0119004	2593159	fungicide	Thiadiazole	9.265		7.928		5.843	
14	3 Methabenzthiazuron	18691-97-9	C10H11N3OS	221.0	221.0622827	18691979	herbicide	Urea	13.461		11.176		7.269	
15	3 Methabenzthiazuron	18691-97-9	C10H11N3OS	221.0	221.0622827	18691979	herbicide	Urea	13.461		11.176		7.269	
16	3 Methabenzthiazuron	18691-97-9	C10H11N3OS	221.0	221.0622827	18691979	herbicide	Urea	13.461		11.176		7.269	
17	3 Methabenzthiazuron	18691-97-9	C10H11N3OS	221.0	221.0622827	18691979	herbicide	Urea	13.461		11.176		7.269	
18	3 Methabenzthiazuron	18691-97-9	C10H11N3OS	221.0	221.0622827	18691979	herbicide	Urea	13.461		11.176		7.269	
19	3 Methabenzthiazuron	18691-97-9	C10H11N3OS	221.0	221.0622827	18691979	herbicide	Urea	13.461		11.176		7.269	
20	3 Methabenzthiazuron	18691-97-9	C10H11N3OS	221.0	221.0622827	18691979	herbicide	Urea	13.461		11.176		7.269	
21	3 Methabenzthiazuron	18691-97-9	C10H11N3OS	221.0	221.0622827	18691979	herbicide	Urea	13.461		11.176		7.269	
22	4 Ethoxyquin	91-53-2	C14H19NO	217.3	217.1466642	91532	fungicide, plant	Quinoline	15.234		12.806		7.795	
23	4 Ethoxyquin	91-53-2	C14H19NO	217.3	217.1466642	91532	fungicide, plant	Quinoline	15.234		12.806		7.795	
24	4 Ethoxyquin	91-53-2	C14H19NO	217.3	217.1466642	91532	fungicide, plant	Quinoline	15.234		12.806		7.795	
25	4 Ethoxyquin	91-53-2	C14H19NO	217.3	217.1466642	91532	fungicide, plant	Quinoline	15.234		12.806		7.795	
26	4 Ethoxyquin	91-53-2	C14H19NO	217.3	217.1466642	91532	fungicide, plant	Quinoline	15.234		12.806		7.795	
27	4 Ethoxyquin	91-53-2	C14H19NO	217.3	217.1466642	91532	fungicide, plant	Quinoline	15.234		12.806		7.795	
28	5 Dicloran (Dichloran)	99-30-9	C6H4Cl2N2O2	207.0	205.9649828	99309	fungicide	Substituted benzen	14.775		12.536		7.798	
29	5 Dicloran (Dichloran)	99-30-9	C6H4Cl2N2O2	207.0	205.9649828	99309	fungicide	Substituted benzen	14.775		12.536		7.798	
30	5 Dicloran (Dichloran)	99-30-9	C6H4Cl2N2O2	207.0	205.9649828	99309	fungicide	Substituted benzen	14.775		12.536		7.798	

Average and exact Molecular Weight

Each pesticide is classified in two categories

# The Flexibility: Excel format, relative and absolute Transition intensity

**MassHunter Format**

**The absolute and relative intensities of transitions**

(Color Scales): Red denotes strong intensity and blue denotes weak intensity among ALL transitions.

			Precursor	MS1	Product	MS2	Dwell Time	CE (V)	Intensity Scale within the Database	Transition Relative Intensity	Quant (Q0) / Qu	Chinese Name	China GB Method Group	Japanese Name	Notes
1	RI - 0502	Common Name	ISTD?	Resolution	Resolution	Resolution	(ms)								
2		Acephate	FALSE	136.0	Wide	94.0	Wide	20	10	130	100%	Q0	乙酰甲胺磷	F	アセフエート
3		Acephate	FALSE	142.1	Wide	96.0	Wide	20	10	30	21%	Q1	乙酰甲胺磷	F	アセフエート
4		Acephate	FALSE	95.0	Wide	78.9	Wide	20	10	20	19%	Q2	乙酰甲胺磷	F	アセフエート
5		Acephate	FALSE	95.0	Wide	79.9	Wide	20	10	20	17%	Q3	乙酰甲胺磷	F	アセフエート
6		Acephate	FALSE	142.1	Wide	65.0	Wide	20	25	20	16%	Q4	乙酰甲胺磷	F	アセフエート
7		Etridiazole (Terrazole, Echlomezol)	FALSE	183.0	Wide	140.0	Wide	20	15	2440	100%	Q0	土菌灵	A	エトリジアゾール
8		Etridiazole (Terrazole, Echlomezol)	FALSE	211.1	Wide	183.0	Wide	20	15	2150	88%	Q1	土菌灵	A	エトリジアゾール
9		Etridiazole (Terrazole, Echlomezol)	FALSE	185.0	Wide	142.1	Wide	20	15	1680	69%	Q2	土菌灵	A	エトリジアゾール
10		Etridiazole (Terrazole, Echlomezol)	FALSE	211.1	Wide	140.0	Wide	20	15	1590	65%	Q3	土菌灵	A	エトリジアゾール
11		Etridiazole (Terrazole, Echlomezol)	FALSE	213.1	Wide	185.0	Wide	20	15	1460	60%	Q4	土菌灵	A	エトリジアゾール
12		Etridiazole (Terrazole, Echlomezol)	FALSE	213.1	Wide	142.1	Wide	20	15	1080	44%	Q5	土菌灵	A	エトリジアゾール
13		Etridiazole (Terrazole, Echlomezol)	FALSE	183.0	Wide	108.0	Wide	20	45	500	20%	Q6	土菌灵	A	エトリジアゾール
14		Methabenzthiazuron	FALSE	164.0	Wide	136.0	Wide	20	5	310	100%	Q0	甲基苯噻隆	D	メタベンズチアズロン
15		Methabenzthiazuron	FALSE	163.1	Wide	136.0	Wide	20	15	190	60%	Q1	甲基苯噻隆	D	メタベンズチアズロン
16		Methabenzthiazuron	FALSE	134.9	Wide	90.9	Wide	20	15	150	49%	Q2	甲基苯噻隆	D	メタベンズチアズロン
17		Methabenzthiazuron	FALSE	134.9	Wide	108.0	Wide	20	15	100	32%	Q3	甲基苯噻隆	D	メタベンズチアズロン
18		Methabenzthiazuron	FALSE	135.9	Wide	109.0	Wide	20	25	90	31%	Q4	甲基苯噻隆	D	メタベンズチアズロン
19		Methabenzthiazuron	FALSE	135.9	Wide	64.9	Wide	20	35	80	25%	Q5	甲基苯噻隆	D	メタベンズチアズロン
20		Methabenzthiazuron	FALSE	163.1	Wide	109.0	Wide	20	15	80	24%	Q6	甲基苯噻隆	D	メタベンズチアズロン
21		Methabenzthiazuron	FALSE	164.0	Wide	108.0	Wide	20	30	50	16%	Q7	甲基苯噻隆	D	メタベンズチアズロン
22		Ethoxyquin	FALSE	202.1	Wide	174.0	Wide	20	15	2890	100%	Q0	乙氧喹啉		
23		Ethoxyquin	FALSE	202.1	Wide	145.1	Wide	20	25	360	12%	Q1	乙氧喹啉		
24		Ethoxyquin	FALSE	203.0	Wide	175.0	Wide	20	15	360	12%	Q2	乙氧喹啉		
25		Ethoxyquin	FALSE	217.0	Wide	202.0	Wide	20	10	360	12%	Q3	乙氧喹啉		
26		Ethoxyquin	FALSE	174.0	Wide	146.1	Wide	20	10	310	11%	Q4	乙氧喹啉		
27		Ethoxyquin	FALSE	202.1	Wide	159.0	Wide	20	30	260	9%	Q5	乙氧喹啉		
28		Dicloran (Dichloran)	FALSE	206.0	Wide	176.0	Wide	20	15	2480	100%	Q0	氯硝胺	B	ジクロラン
29		Dicloran (Dichloran)	FALSE	207.9	Wide	178.0	Wide	20	15	1560	63%	Q1	氯硝胺	B	ジクロラン
30		Dicloran (Dichloran)	FALSE	124.0	Wide	73.1	Wide	20	15	1410	57%	Q2	氯硝胺	B	ジクロラン

**One Quant and several Qualifications for each compound**



# Click on the sorting button to show/hide Quant and Qualifier Ions

The screenshot shows an Excel spreadsheet titled 'MRM Database.xlsx'. The data table has columns for various parameters including 'Common Name', 'Precursor I<sub>c</sub>', 'MS1 Resolution', 'Product I<sub>c</sub>', 'MS2 Resolution', 'Dwell Time', 'CE (V)', 'Intensity Scale within the Database', 'Transition Relative Intensity', 'Quant (Q0)/Qual', 'China GB Method', and 'Japanese Name'. A sorting menu is open over the 'Quant' column, with a red arrow pointing to the 'Sort A to Z' button. The menu also includes options for 'Sort Z to A', 'Sort by Color', 'Clear Filter From "Quant (Q0)/Qual"', 'Filter by Color', and 'Text Filters'. The 'Text Filters' sub-menu is open, showing a list of checkboxes for Q0 through Q7, with Q0, Q1, and Q2 checked.

Common Name	Precursor I <sub>c</sub>	MS1 Resolution	Product I <sub>c</sub>	MS2 Resolution	Dwell Time (ms)	CE (V)	Intensity Scale within the Database	Transition Relative Intensity	Quant (Q0)/Qual	China GB Method	Japanese Name
Acephate	136.0	Wide	94.0	Wide	20	10				F	アセフエート
Acephate	142.1	Wide	96.0	Wide	20	10				F	アセフエート
Acephate	95.0	Wide	78.9	Wide	20	10				F	アセフエート
Acephate	95.0	Wide	79.9	Wide	20	10				F	アセフエート
Acephate	142.1	Wide	65.0	Wide	20	25				F	アセフエート
Etridiazole (Terrazole, Echlomezol)	183.0	Wide	140.0	Wide	20	15				A	エトリジアゾール
Etridiazole (Terrazole, Echlomezol)	211.1	Wide	183.0	Wide	20	15				A	エトリジアゾール
Etridiazole (Terrazole, Echlomezol)	185.0	Wide	142.1	Wide	20	15				A	エトリジアゾール
Etridiazole (Terrazole, Echlomezol)	211.1	Wide	140.0	Wide	20	15				A	エトリジアゾール
Etridiazole (Terrazole, Echlomezol)	213.1	Wide	185.0	Wide	20	15				A	エトリジアゾール
Etridiazole (Terrazole, Echlomezol)	213.1	Wide	142.1	Wide	20	15				A	エトリジアゾール
Etridiazole (Terrazole, Echlomezol)	183.0	Wide	108.0	Wide	20	45				A	エトリジアゾール
Methabenzthiazuron	164.0	Wide	136.0	Wide	20	5				D	メタベンズチアズロン
Methabenzthiazuron	163.1	Wide	136.0	Wide	20	15				D	メタベンズチアズロン
Methabenzthiazuron	134.9	Wide	90.9	Wide	20	15				D	メタベンズチアズロン
Methabenzthiazuron	134.9	Wide	108.0	Wide	20	15				D	メタベンズチアズロン
Methabenzthiazuron	135.9	Wide	109.0	Wide	20	25				D	メタベンズチアズロン
Methabenzthiazuron	135.9	Wide	64.9	Wide	20	35				D	メタベンズチアズロン
Methabenzthiazuron	163.1	Wide	109.0	Wide	20	15				D	メタベンズチアズロン
Methabenzthiazuron	164.0	Wide	108.0	Wide	20	30				D	メタベンズチアズロン
Ethoxyquin	202.1	Wide	174.0	Wide	20	15	2890	100%	Q0		乙氧喹啉
Ethoxyquin	202.1	Wide	145.1	Wide	20	25	360	12%	Q1		乙氧喹啉
Ethoxyquin	203.0	Wide	175.0	Wide	20	15	360	12%	Q2		乙氧喹啉
Ethoxyquin	217.0	Wide	202.0	Wide	20	10	360	12%	Q3		乙氧喹啉
Ethoxyquin	174.0	Wide	146.1	Wide	20	10	310	11%	Q4		乙氧喹啉
Ethoxyquin	202.1	Wide	159.0	Wide	20	30	260	9%	Q5		乙氧喹啉
Dicloran (Dichloran)	206.0	Wide	176.0	Wide	20	15	2480	100%	Q0	B	ジクロラン
Dicloran (Dichloran)	207.9	Wide	178.0	Wide	20	15	1560	63%	Q1	B	ジクロラン
Dicloran (Dichloran)	124.0	Wide	73.1	Wide	20	15	1410	57%	Q2	B	ジクロラン

# Use the sorting function to quickly select a Quant (Q0) and top three Qualifier ions (to build a method)!

MRM Database.xlsx - Microsoft Excel

	O	P	Q	R	S	T	U	V	W	X	Y	Z	AA	AB	AC	AD	AE
1	RI - 0502	Common Name	ISTD?	Precursor I <sub>c</sub>	MS1 Resolution	Product I <sub>c</sub>	MS2 Resolution	Dwell Time (ms)	CE (V)	Intensity Scale within the Database	Transition Relative Intensity (%)	Quant (Q0) / Qualifier	Chinese Name	China GB Method Group	Japanese Name	Note	
2		Acephate	FALSE	136.0	Wide	94.0	Wide	20	10	130	100%	Q0	乙酰甲胺磷	F	アセフエート		
3		Acephate	FALSE	142.1	Wide	96.0	Wide	20	10	30	21%	Q1	乙酰甲胺磷	F	アセフエート		
4		Acephate	FALSE	95.0	Wide	78.9	Wide	20	10	20	19%	Q2	乙酰甲胺磷	F	アセフエート		
5		Acephate	FALSE	95.0	Wide	79.9	Wide	20	10	20	17%	Q3	乙酰甲胺磷	F	アセフエート		
7		Etridiazole (Terrazole, Echlomezol)	FALSE	183.0	Wide	140.0	Wide	20	15	2440	100%	Q0	土菌灵	A	エトリジアゾール		
8		Etridiazole (Terrazole, Echlomezol)	FALSE	211.1	Wide	183.0	Wide	20	15	2150	88%	Q1	土菌灵	A	エトリジアゾール		
9		Etridiazole (Terrazole, Echlomezol)	FALSE	185.0	Wide	142.1	Wide	20	15	1680	69%	Q2	土菌灵	A	エトリジアゾール		
10		Etridiazole (Terrazole, Echlomezol)	FALSE	211.1	Wide	140.0	Wide	20	15	1590	65%	Q3	土菌灵	A	エトリジアゾール		
14		Methabenzthiazuron	FALSE	164.0	Wide	136.0	Wide	20	5	310	100%	Q0	甲基苯噻隆	D	メタベンズチアズロン		
15		Methabenzthiazuron	FALSE	163.1	Wide	136.0	Wide	20	15	190	60%	Q1	甲基苯噻隆	D	メタベンズチアズロン		
16		Methabenzthiazuron	FALSE	134.9	Wide	90.9	Wide	20	15	150	49%	Q2	甲基苯噻隆	D	メタベンズチアズロン		
17		Methabenzthiazuron	FALSE	134.9	Wide	108.0	Wide	20	15	100	32%	Q3	甲基苯噻隆	D	メタベンズチアズロン		
22		Ethoxyquin	FALSE	202.1	Wide	174.0	Wide	20	15	2890	100%	Q0	乙氧喹啉				
23		Ethoxyquin	FALSE	202.1	Wide	145.1	Wide	20	25	360	12%	Q1	乙氧喹啉				
24		Ethoxyquin	FALSE	203.0	Wide	175.0	Wide	20	15	360	12%	Q2	乙氧喹啉				
25		Ethoxyquin	FALSE	217.0	Wide	202.0	Wide	20	10	360	12%	Q3	乙氧喹啉				
28		Dicloran (Dichloran)	FALSE	206.0	Wide	176.0	Wide	20	15	2480	100%	Q0	氯硝胺	B	ジクロラン		
29		Dicloran (Dichloran)	FALSE	207.9	Wide	178.0	Wide	20	15	1560	63%	Q1	氯硝胺	B	ジクロラン		
30		Dicloran (Dichloran)	FALSE	124.0	Wide	73.1	Wide	20	15	1410	57%	Q2	氯硝胺	B	ジクロラン		
31		Dicloran (Dichloran)	FALSE	176.1	Wide	148.0	Wide	20	15	1100	44%	Q3	氯硝胺	B	ジクロラン		

# Click on the sorting button to select/show the compounds to be added into the acquisition method

The screenshot shows an Excel spreadsheet titled "MRM Database.xlsx" with a table of compound data. A dropdown menu is open for the "Common Name" column, showing options like "Sort A to Z", "Sort Z to A", and "Filter by Color". A text box at the bottom of the spreadsheet contains the following text:

It is easy to add a column to associate each compound with a lab method or study to allow a quick sort to build an acq. method.

1	RI - 0502	Common Name	ISTD?	Precursor	MS1	Product	MS2	Dwell Time	CE (V)	Intensity	Transition Relative Intensity	Quant	Chinese Name	China GB Method	Japanese Name	Notes
2		Acephate	FALSE	136.0	Wide	94.0	Wide	20	10	130	100%	Q0	乙酰甲胺磷	F	アセフエート	
3		Acephate	FALSE	142.1	Wide	96.0	Wide	20	10	30	21%	Q1	乙酰甲胺磷	F	アセフエート	
4		Acephate	FALSE	95.0	Wide	78.9	Wide	20	10	20	19%	Q2	乙酰甲胺磷	F	アセフエート	
5		Acephate	FALSE	95.0	Wide	79.9	Wide	20	10	20	17%	Q3	乙酰甲胺磷	F	アセフエート	
7		Etridiazole	FALSE	183.0	Wide	140.0	Wide	20	15	2440	100%	Q0	土菌灵	A	エトリジアゾール	
8		Etridiazole	FALSE	211.1	Wide	183.0	Wide	20	15	2150	88%	Q1	土菌灵	A	エトリジアゾール	
9		Etridiazole	FALSE	185.0	Wide	142.1	Wide	20	15	1680	69%	Q2	土菌灵	A	エトリジアゾール	
10		Etridiazole	FALSE	211.1	Wide	140.0	Wide	20	15	1590	65%	Q3	土菌灵	A	エトリジアゾール	
14		Methabenzthiazuron	FALSE	164.0	Wide	136.0	Wide	20	5	310	100%	Q0	甲基苯噻隆	D	メタベンズチアズロン	
15		Methabenzthiazuron	FALSE	163.1	Wide	136.0	Wide	20	15	190	60%	Q1	甲基苯噻隆	D	メタベンズチアズロン	
16		Methabenzthiazuron	FALSE	134.9	Wide	90.9	Wide	20	15	150	49%	Q2	甲基苯噻隆	D	メタベンズチアズロン	
17		Methabenzthiazuron	FALSE	134.9	Wide	108.0	Wide	20	15	100	32%	Q3	甲基苯噻隆	D	メタベンズチアズロン	
22		Ethoxyquin	FALSE	202.1	Wide	174.0	Wide	20	15	2890	100%	Q0	乙氧喹啉			
23		Ethoxyquin	FALSE	202.1	Wide	145.1	Wide	20	25	360	12%	Q1	乙氧喹啉			
24		Ethoxyquin	FALSE	203.0	Wide	175.0	Wide	20	15	360	12%	Q2	乙氧喹啉			
25		Ethoxyquin	FALSE	217.0	Wide	202.0	Wide	20	10	360	12%	Q3	乙氧喹啉			
28		Dicloran (Dichloran)	FALSE	206.0	Wide	176.0	Wide	20	15	2480	100%	Q0	氯硝胺	B	ジクロラン	
29		Dicloran (Dichloran)	FALSE	207.9	Wide	178.0	Wide	20	15	1560	63%	Q1	氯硝胺	B	ジクロラン	
30		Dicloran (Dichloran)	FALSE	124.0	Wide	73.1	Wide	20	15	1410	57%	Q2	氯硝胺	B	ジクロラン	
31		Dicloran (Dichloran)	FALSE	176.1	Wide	148.0	Wide	20	15	1100	44%	Q3	氯硝胺	B	ジクロラン	

# Why Do We Need More than 2 MRM Transitions?

Signal-to-Noise Ratio Comparison for MRM Transitions in Spinach and Orange

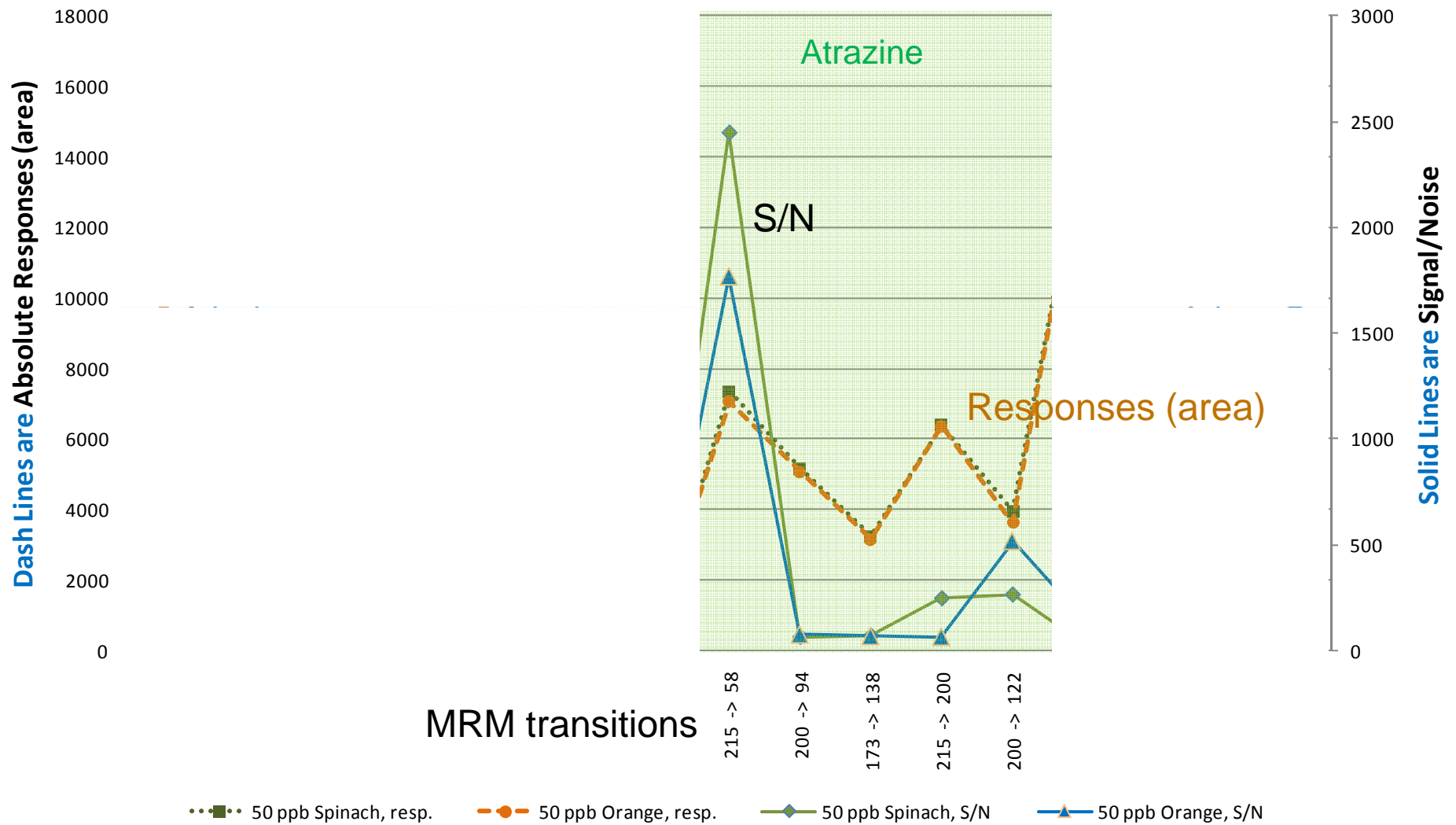

# MRM Transitions are not Universal, Should Choose them According to Matrices

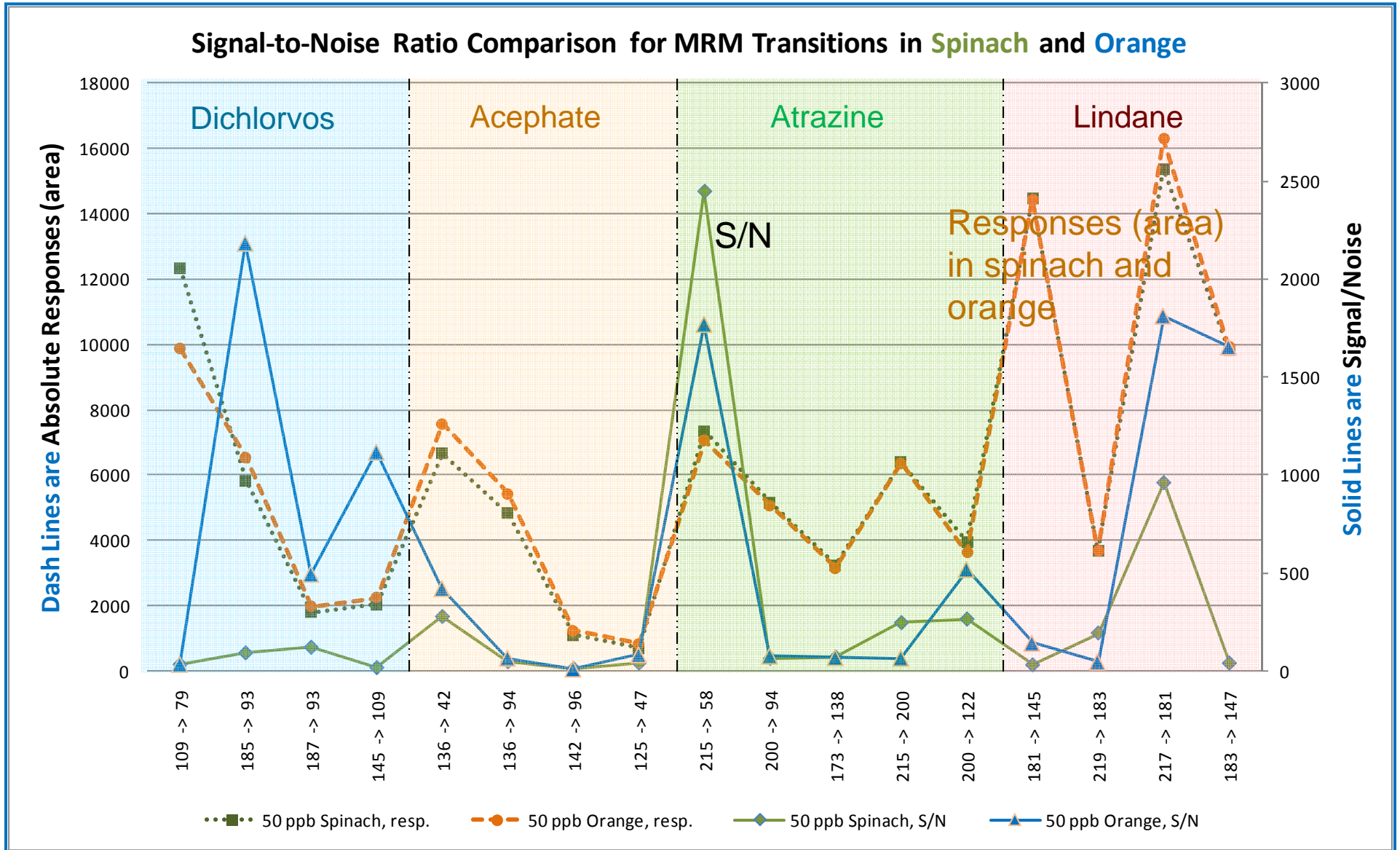

## Summary: Pesticide GC/MS/MS Analyzer

The Pesticide GC/MS/MS Analyzer is **tested as a unit** in the factory to ensure a quick and successful installation

New **flexible and comprehensive** Pesticide MRM Database expands the target compound list to 1000 to meet users' need

### The MRM Database

- allows users to build acquisition methods without acquiring expensive or hard-to-get pesticide standards (saves time and money)
- applies to either constant flow or constant pressure method (adapts to user's preference or analytical method)
- has multiple MRM transitions (average 7) for each compound (helps to provide alternatives to work around matrix interference)
- shows relative intensity of each MRM transition (facilitates transition selection and acquisition method creation)